

Data Sheet

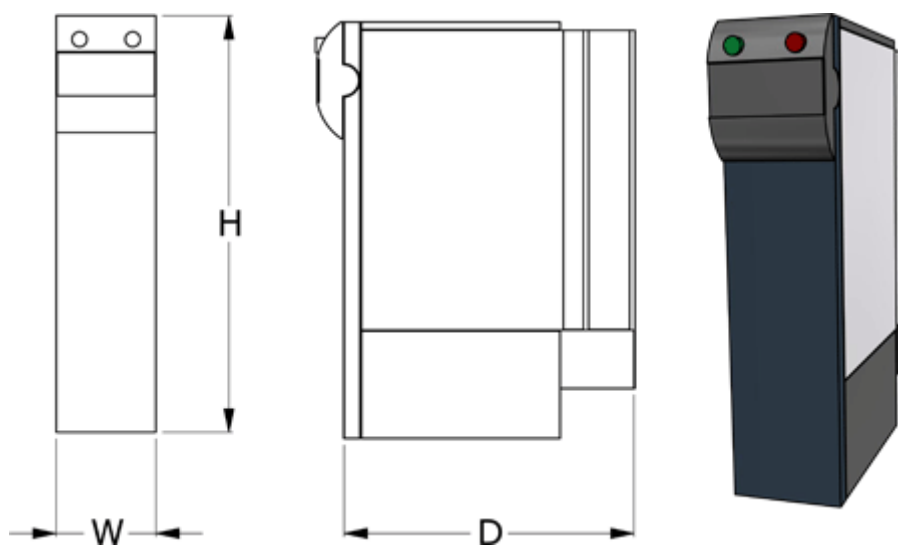

Article number: 1080201131000
Description: Servocontroller ACU201-13-FA
2,2 kW 9,5A 1x230V IP20

Measures



D = 175
H = 250
W = 60
Weight = 1.6